

# MANUAL

**Geneva Sound System  
(Model L & XL)**

**GENEVA™**  
GENEVALAB.COM

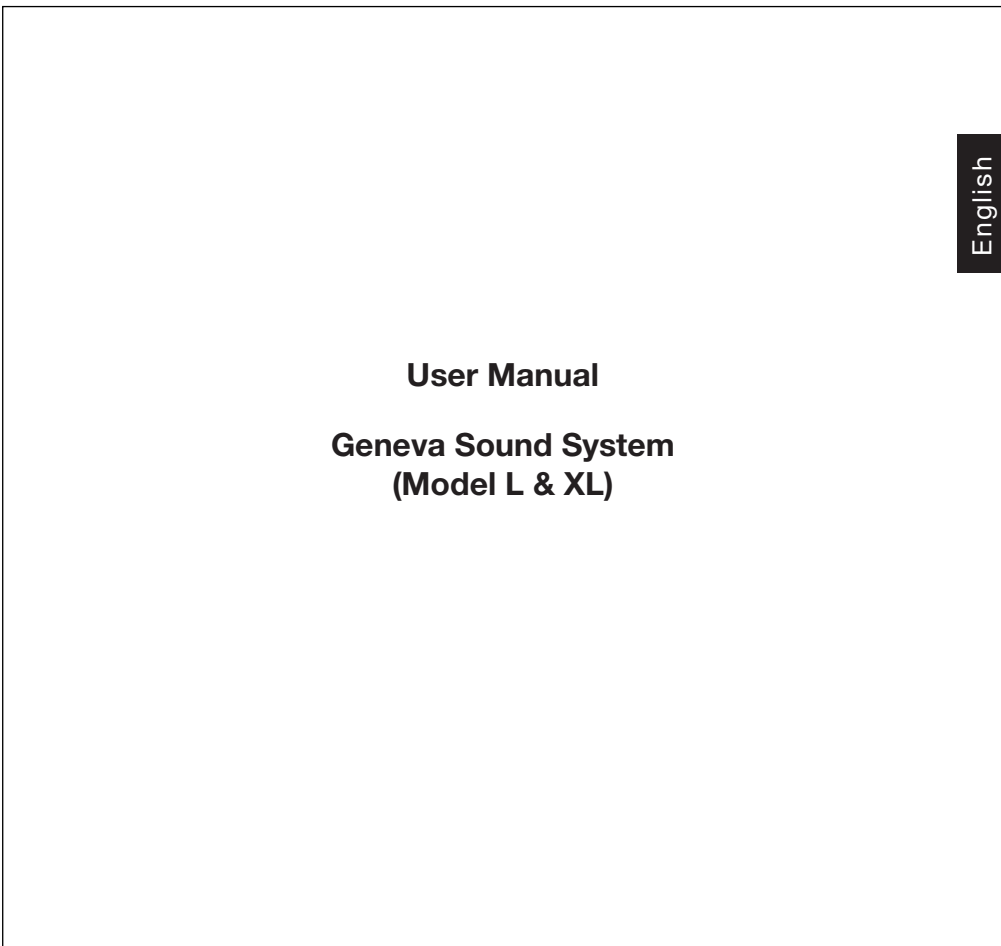

English

**User Manual**  
**Geneva Sound System**  
**(Model L & XL)**

## Notice

This User Manual is available in larger font size for easier reading.  
You can download it from [www.genevalab.com](http://www.genevalab.com) and select support page

## WARNING

TO PREVENT FIRE OR SHOCK HAZARD. DO NOT EXPOSE THIS APPLIANCE TO RAIN OR MOISTURE.

### CAUTION

RISK OF ELECTRICAL SHOCK  
DO NOT OPEN

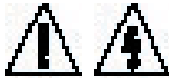

### AVIS

RISQUE DE CHOC ÉLECTRIQUE  
NE PAS OUVRIR

**Warning:** To reduce the risk of electric shock, do not remove the cover (or back), no user serviceable parts inside. Refer servicing to qualified service personnel.

English

## IMPORTANT SAFETY INSTRUCTIONS

- 1) **Read** these instructions.
- 2) **Keep** these instructions.
- 3) **Heed** all warnings.
- 4) **Follow** all instructions.
- 5) **Do not** use this apparatus near water.
- 6) **Clean** only with dry cloth.
- 7) **Do not block any ventilation openings.** Install in accordance with the manufacturer's instructions.
- 8) **Do not install near any heat sources** such as radiators, heat registers, stoves, or other apparatus (including amplifiers) that produce heat.
- 9) **Do not defeat the safety purpose** of the polarized or grounding-type plug. A polarized plug has two blades with one wider than the other. A grounding type plug has two blades and a third grounding prong. The wide blade or the third prong are provided for your safety. If the provided plug does not fit into your outlet, consult an electrician for replacement of the obsolete outlet.
- 10) **Protect the power cord** from being walked on or pinched particularly at plugs, convenience receptacles, and the point where they exit from the apparatus.

6

- 11) **Only use attachments/accessories** specified by the manufacturer.
- 12) **Use only with the cart, stand, tripod, bracket, or table** specified by the manufacturer, or sold with the apparatus. When a cart is used, use caution when moving the cart/apparatus combination to avoid injury from tip-over.



- 13) **Unplug this apparatus** during lightning storms or when unused for long periods of time.
- 14) **Refer all servicing to qualified** service personnel. Servicing is required when the apparatus has been damaged in any way, such as power-supply cord or plug is damaged, liquid has been spilled or objects have fallen into the apparatus, the apparatus has been exposed to rain or moisture, does not operate normally, or has been dropped.
- 15) **This appliance shall not be exposed to dripping or splashing water** and that no object filled with liquids such as vases shall be placed on apparatus.

7

English

**Caution:** Use of controls or adjustments or performance of procedures other than herein may result in hazardous radiation exposure or other unsafe operation.

**Compact Disk Drive:** The compact disk (CD) drive contains a laser. The laser radiates visible and invisible laser radiation. Do not open optical housing. Avoid direct exposure to the beam.  
The compact disc player should not be adjusted or repaired by anyone except properly qualified service personnel.

**Class 1 laser product:** This CD player is classified as a CLASS 1 LASER PRODUCT according to EN 60825- 1:1994+A1+A2, IEC 60825-1:1993+A1+A2. The CLASS 1 LASER PRODUCT label is located on the bottom plate of the product. This product complies with 21 CFR Part 1040.10.

Technical details about the incorporated laser diode: Wavelength: 790 nm ± 15nm.  
Max accessible radiant power (during service): 0.492 mW.

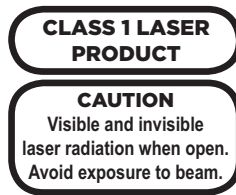

**Ventilation:** Do not block any ventilation openings on the back or under the Geneva Sound System. To ensure reliable operation of the Geneva Sound System and to protect it from overheating, put the System in a position and location that will not interfere with its proper ventilation. For example, do not place the Geneva Sound System on a bed, sofa, or similar surface that may block the ventilation openings. Do not put it in a built-in position, such as in a bookcase or in a cabinet that may keep air from flowing through its ventilation openings. Do not push objects of any kind through openings.

English

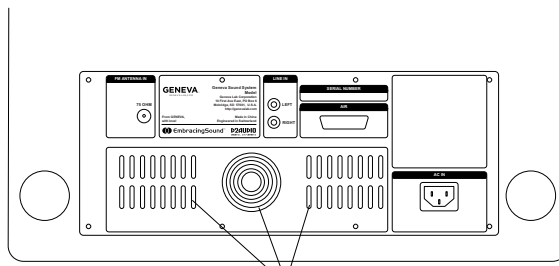

Ventilation holes

**Cleaning:** Please note we have included a cleaning cloth with your Geneva Sound System, in the accessory bag. To avoid making scratches to the surface, we recommend that you use the cleaning cloth included. Before cleaning, please unplug this Geneva Sound System from the AC power outlet.

**Overloading:** To prevent risk of fire or electric shock, avoid overloading wall outlets or extension cords.

**Open fire:** Keep this Geneva Sound System a safe distance away from any open flame such as a lit candle. No open flame sources, such as lighted candles, should be placed on the Geneva Sound System.

**Operating Temperatures:** The recommended operating temperature range for the Geneva Sound System is 41 to 104 degrees Fahrenheit (5 to 40 degrees Celsius).

**Unpacking:** It is recommended to use two people when unpacking the Geneva Sound System. The Geneva Sound System model L weighs more than 38 Pounds/17kg and model XL more than 84 Pounds/38kg.

**Front grille panel:** Never remove front grille panel because the panel is non detachable and will void the Limited Warranty.

**Sitting or Leaning on Geneva Sound System:** Do not lean against the Geneva Sound System and do not sit on it under any circumstances.

**Avoid Hearing Damage:** Playing very loud music for an extended period of time can result in permanent hearing loss.

**Operating Position:** Use only with the attached rubber feet or the special floor stand that has been designed for this product and sold by Geneva Lab Corporation.

**The mains plug** or appliance coupler is used as the disconnect device, such disconnect device shall remain readily operable.

**Label location:** The product labels and safety related markings are located on the Bottom Panel of the Geneva Sound System.

**Accessing the Bottom Panel:** Be careful if you turn the Geneva Sound System over to access the Bottom Panel on the bottom of the Geneva Sound System. Never rest the speaker on its front side (the side with the metal grille panel) – the weight of the speaker will deform the grille.

For easier access to this Bottom Panel, place the Geneva Sound System on one of its short sides. Ensure that the System is placed on a soft material (carpet or textile) that does not scratch the surface.

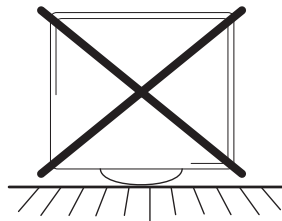

**Unplugging while in operation:** Do not remove the AC power cord out of the AC outlet if music is playing or if the Geneva Sound System is turned on. The drivers can be damaged by such an action.

**Batteries in the remote control:** Keep the remote control battery away from children. It may cause a fire or chemical burn if mishandled. Do not recharge, disassemble, heat above 212°F (100°C), or incinerate. Replace only with a battery of the correct type and model number (CR2025 lithium coin cell battery, 3 V).

**CAUTION:** Danger explosion if battery is incorrectly replaced. Replace only with the same or equivalent type.

**Used batteries:** Please dispose of used batteries properly, following any local regulations. Do not incinerate.

**iPod Universal Dock:** Never insert the iPod into the iPod Universal Dock if the appropriate plastic Dock Adapter is not inserted.

**Compact Disks (CD's):** Do not insert smaller disks than 12 cm, such as a CD mini disk, etc., which are not supported. Also, do not insert anything else than a CD, such as coins.

**Outside Antenna:** If an outside antenna or cable system is connected to this product, be sure the antenna or cable system is grounded so as to provide some protection against voltage surges and built-up static charges. Article 810 of the National Electric Code, ANSI/NFP No. 70 information, Section 54 of the Canadian Electrical Code, with regard to proper grounding of the mast and supporting structure, grounding of the lead-in wire to an antenna discharge unit, size of grounding conductors, location of antenna/discharge unit, connection to grounding electrodes, and requirements for the grounding electrode.

**Modification:** Unauthorized modification of the receiver or radio remote control could void the user's authority to operate this equipment.

**Note to CATV system installer:** This reminder is provided to call the CATV system installer's attention to Article 820-40 of the NEC (of USA) that provides guidelines for proper grounding. In particular, it specifies that the cable ground shall be connected to the grounding system of the building, as close to the point of cable entry as is practical.

**Removal of the Bottom Panel:** By any unauthorized person also voids the Limited Warranty.

**This product can be recycled.** Products bearing this symbol must NOT be thrown away with normal household waste. At the end of the product's life, take it to a collection point designated for recycling of electrical and electronic devices. Find out more about return and collection points through your local authority.

The European Waste Electrical and Electronic Equipment (WEEE) Directive was implemented to dramatically reduce the amount of waste going to landfills, there by reducing the environmental impact on the planet and on human health. Please act responsibly by recycling used products. If this product is still usable, consider giving it away or selling it.



## Contents

### Chapter 1 16 Getting Started

- 16 Unpacking and setting up
- 21 Quick Start
- 24 Listen to your iPod
- 26 Listen to a CD
- 27 Listen to the FM radio

### Chapter 2 28 How To...?

#### *General:*

- 28 How to turn the Geneva Sound System on and off?
- 28 How to adjust Volume and Sound?
- 29 How to verify that the remote control works?
- 29 How to clean the speaker?
- 30 How to change battery in the remote control?

#### *iPod:*

- 30 How to select the right iPod Dock adapter for my iPod?
- 32 How to check if my iPod is compatible with the Geneva Sound System?
- 33 How to insert or remove a Dock Adapter?
- 34 How to control the iPod using the Geneva Sound System's remote control?

#### *CD:*

- 35 How to control the CD player using the remote control?
- 36 How to play CD's with MP3 and other formats?
- 36 How to play MP3 CD-R/W with several Albums?

#### *FM radio:*

- 37 How to control the FM radio using the remote control?
- 38 How to select a FM radio station?
- 38 How to store your favorite FM radio station in a preset?
- 39 How to play a FM radio station that is stored in the presets?
- 39 How to erase or overwrite a preset?
- 39 How to connect the External FM radio antenna?

#### *Line in:*

- 40 How to connect a Computer, iPod Shuffle or another MP3 player to the Geneva Sound System using the 1/8 inch (3.5 mm) input?
- 40 How to connect a TV, Computer, VCR, DVD player or a game console to the Geneva Sound System using the "Line in" input?

### Chapter 3 41 Troubleshooting, Service and Support

- 41 Troubleshooting and Support
- 41 Service and Repair
- 41 Technical Support
- 41 Customer Service Telephone Number
- 41 Website

### Chapter 4 42 Made for iPod & Technology Partners

- 42 Made for iPod
- 42 Technology Partners

### Chapter 5 44 Technical Specifications

## 1. Getting Started

**Step 1:** Unpack all components from the shipping box. Please be aware that the Geneva Sound System model L and XL are heavy, so it is better to have two people lift it out of the box. Please save the original packaging material in case you ever need to return the System since the Limited Warranty does not cover shipping damages. Geneva Lab Corporation's 30-day return policy only covers products returned in the original packaging in as new condition.

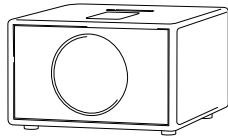

Cabinet / model L

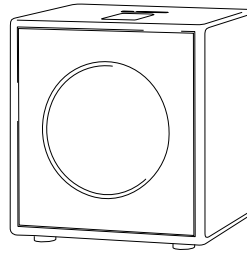

Cabinet / model XL

The shipping box should contain the following System components:

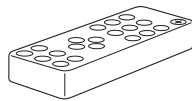

Remote control



iPod dock adapters



AC Power cord

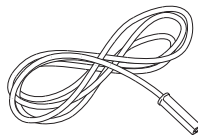

External antenna

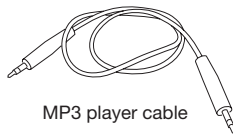

MP3 player cable

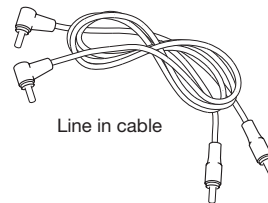

Line in cable

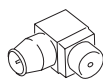

Antenna adapter

**Step 2:** Insert the batteries into the remote control (see page 30). There are batteries included in the package.

**Step 3:** Place the Geneva Sound System on one of its short sides. Ensure that the System is placed on a soft material (carpet or textile) that does not scratch the surface. Insert the AC power cable into the AC connector on the Bottom Panel (see picture below) and then connect it to an AC outlet.

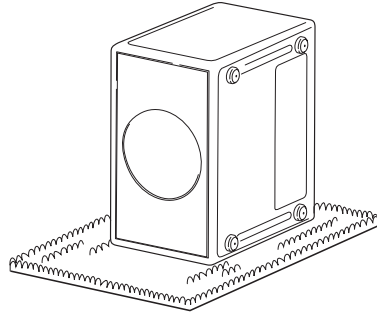

18

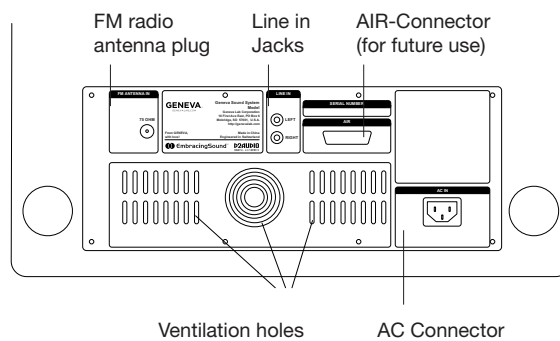

English

**Please Note:** If you have purchased a Floor Stand made for the Geneva Sound System, assemble the Stand, remove the four rubber feet from the main Cabinet and attach the Stand using the screws provided with the Stand. For detailed assembly, see Manual provided in the Stand package.

**Step 4:** Return the system to an up-right position, so it stands on its four rubber feet.

19

**Step 5:** If you intend to use the System with an iPod, open the lid on top of the cabinet. To open, please press carefully on the rear part of the lid.

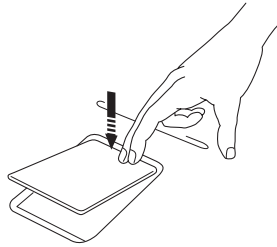

Open

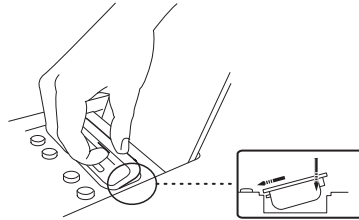

Attach

Select the right iPod Dock Adapters that fits with the iPod model you intend to dock by following the table on page 31, or try the enclosed Dock Adapters until you find the one that fits tightly with your iPod. Attach the Dock Adapter to the iPod Universal Dock by pressing lightly on the top of the Dock Adapter (see picture) and it will snap in.

**Quick start:**

**Universal Dock panel** with control keys for on/off, volume and CD Eject

**CD Player**

**iPod Universal Dock**

**LED Display** showing system mode, FM frequency, CD status, etc.

**Front Grille**

**Electronics Panel**

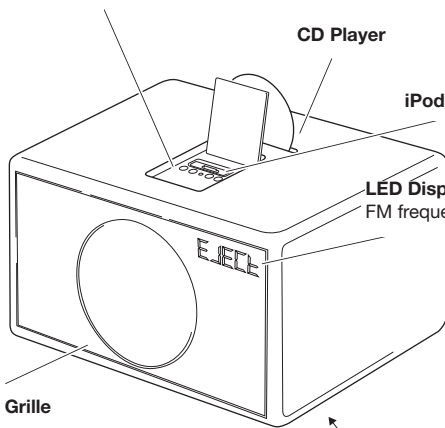

**Control buttons and iPod Universal Dock found on panel under the lid on top of Cabinet:**

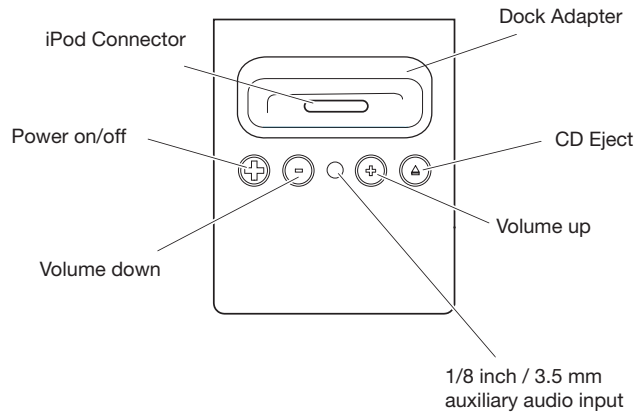

**Remote control:**

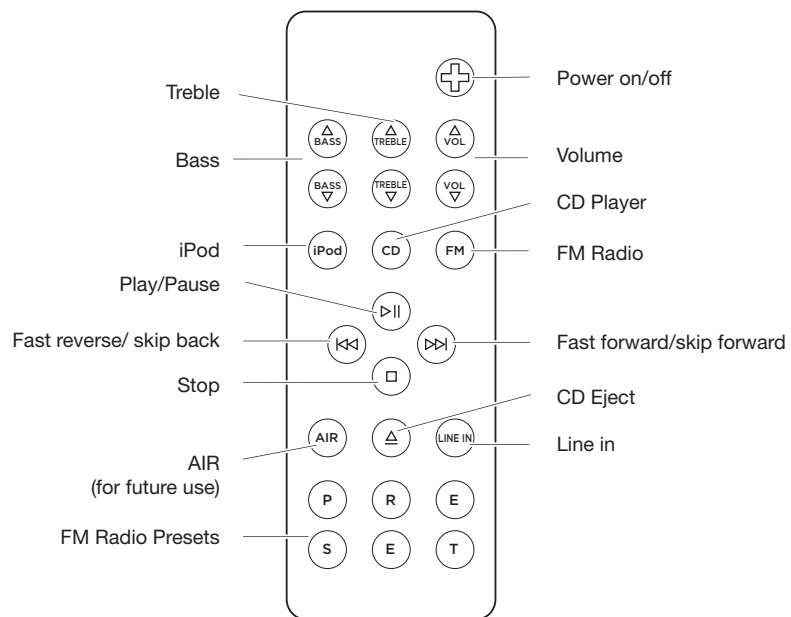

English

**Turn on the Geneva Sound System:**

Press the power on/off key on the remote control or the on/off key next to the Universal Dock under the lid on top of the Cabinet.

**Select source:**

To switch between sources, press either iPod, CD, FM or Line In key on the remote control to select which source to be controlled.

**Listen to your iPod (more details on page 30):**

**Step 1.** Insert the iPod in the corresponding Dock Adapter in the iPod Universal Dock.

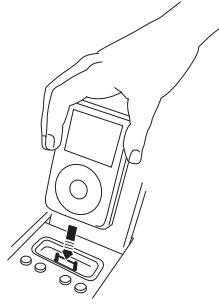

Press the iPod key on the remote control and the LED Display under the grille should display "iPod". If the display does not lit up, check that the AC power cord is correctly inserted in to functioning AC outlet.

**Step 2.** Press the Play key on the remote control or press the key next to the Universal Dock. If you still cannot hear any sound check that the volume is turned up by adjusting the "+" volume key.

**Step 3.** You can navigate your iPod using the Stop, Play/Pause, Skip/Fast Forward, Skip/Fast Reverse keys on your remote control.

**Step 4.** The iPod is charging when placed in the Universal Dock and the System is powered.

**Listen to a CD (more details on page 35):**

**Step 1.** Insert the CD into the slot – make sure the printed side of the CD is facing the front of the Cabinet (see temporary label next to CD slot for loading instructions). The LED Display under the grille should display “CD” and the CD should start playing automatically. If the display does not light up then check that the AC power cord is correctly inserted in to functioning AC outlet. If you still cannot hear any sound, check that the volume is turned up by adjusting the “+” volume key.



**Step 2.** You can navigate the CD player by using the Stop, Play/Pause, Skip/Fast Forward and Skip/Fast Reverse keys on your remote control.

**Step 3.** To remove the CD, either press the Eject key on the remote control or the Eject key next to the Universal Dock under the lid on top of the Cabinet.

**Listen to the FM radio (more details on page 37):**

**Step 1.** Connect the External antenna to the External FM antenna connector on the Bottom Panel under the Geneva Sound System.

**Step 2.** Press the FM button on the remote control and the LED Display under the grille should display an FM frequency, e.g. “103.2”. If the display does not light up, check that the AC power cord is correctly inserted into a functioning AC outlet. If you still cannot hear any sound, check that the volume is turned up by adjusting the “+” volume key.

**Step 3.** Select an FM station with the << and >> keys.

## 2. How to...?

### General:

#### How to turn the Geneva Sound System on and off?

The System is always in standby mode and can be controlled by the remote control or by using the keys next to the Universal Dock under the lid on top of the Cabinet.

#### You can turn On the Geneva Sound System by any of the following actions:

- Pressing the FM, iPod, CD, or Line In keys on the remote control
- Pressing the on/off key on the remote control
- Pressing the on/off key next to the Universal Dock under the lid on top of the Cabinet.

#### You can turn Off the Geneva Sound System by any of the following actions:

- By pressing either the ON/OFF key on the remote control or the on/off key next to the Universal Dock under the lid on top of the Cabinet.

#### How to adjust Volume and Sound?

1. Use the Volume, Bass and Treble keys on the remote control to adjust sound and volume. You can also use the Volume key next to the Universal Dock under the lid on top of the Cabinet to adjust the volume.

2. The volume range on display: 0 means silence (no sound output), 100 means maximum output.
3. Treble and Bass: -6 means very little bass or treble, 0 means neutral , 6 means maximum bass or treble.
4. If you turn the device off, the current values are stored. So if it is at a very high volume when turned off, it will be at a very high volume when it is next turned on.

#### How to verify that the remote control works?

Every time a key is pressed on the remote control, a small red light on the LED Display lights up quickly.

#### How to clean the speaker?

Unplug this Geneva Sound System from the AC power outlet before cleaning. Clean only with a dry cloth. To avoid making scratches to the surface, we recommend that you use the cleaning cloth included in the accessory bag.

Warning – Do not use cleaning alcohol, or other solvent fluids to clean the surface of the Cabinet as this can both damage the lacquer and also cause electrical failures and fire if it enters the electronics in the Geneva Sound System!

**How to change battery in the remote control?**



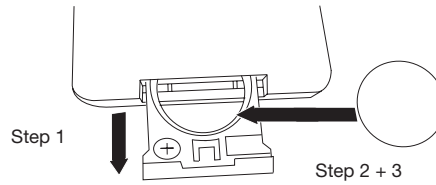







1. Open the battery lid that is on the backside of the remote control.
2. Remove the existing battery and replace it with a new lithium cell, 3 V battery (CR2025 type).
3. Inside the battery compartment there are symbols showing in which direction the batteries should be placed. Carefully follow these directions.



**iPod:**

**How to select the right iPod Dock adapter for my iPod?**







The Geneva Sound System supports all the iPod models that are listed in the table below. Select the Dock Adapter with the number printed on the grey area that corresponds with the iPod model you wish to use, as set out in the table to the right:

Dock Adapter number	Made for	Hard Disk Capacity
Included with the purchase of your iPod video	 iPod video	
Included with the purchase of your iPod nano	 iPod nano	
7	 iPod with color display (fat)	60GB only
6	 iPod with color display (thin)	20GB only
7	 iPod photo (fat)	60GB only
6	 iPod photo (thin)	30GB only
5	 4G iPod (fat)	40 GB only
4	 4G iPod (thin)	20GB only
3	 4G iPod mini	4GB, 6GB only
2	 3G iPod (fat)	30GB, 40GB only
1	 3G iPod (thin)	10GB, 15GB, 20GB only

Note: 3G refers to 3rd generation iPod models and 4G to the 4th generation iPod model

### How to check if my iPod is compatible with the Geneva Sound System?

The table below sets out the iPod software version that is required for it to be compatible with the Geneva Sound System:

Made for	Required iPod Software Version
 iPod video	1.0
 iPod nano	1.0
 iPod with color display (20GB, 60GB only)	1.0
 iPod photo (20GB, 30GB only)	1.0
 4G iPod (20GB, 40GB only)	3.0
 iPod mini (4GB, 6GB only)	1.2
 3G iPod (10GB, 15GB, 20GB, 30GB, 40GB only)	2.3

### How to check the software version of your iPod?

On the iPod select "Settings", "About", "Version".

### How to upgrade your iPod?

On the Apple iPod website you will find instructions on how to upgrade the software of your iPod: [www.apple.com/ipod/download/](http://www.apple.com/ipod/download/)

### How to insert or remove a Dock Adapter?

Insert the Dock Adapter to the iPod Universal Dock by pressing lightly on the top of the Dock Adapter (see picture below) and it will snap in.

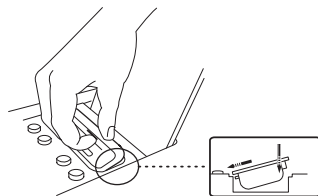

Insert

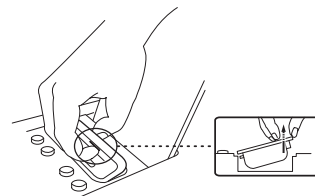





Remove

Remove an inserted Dock Adapter by pressing toward the front and at the same time carefully lift the back of the adapter using your fingernail or other non-metal device that does not damage the plastics.

**How to control the iPod using the Geneva Sound System's remote control?**







If you have inserted an iPod into the Universal Dock and turned the Geneva Sound System into iPod mode, you can control the iPod using the remote control supplied with the Geneva Sound System. Simply follow the instructions in the table below to perform control the various functions:

Key	Function
	Select iPod
	Play/Pause
	Skip/Fast Forward
	Skip/ Fast Reverse

**CD:**

**How to control the CD player using the remote control?**

You can control the built-in CD player using the remote control supplied with the Geneva Sound System. Simply follow the instructions in the table below to perform control the various functions:

Key	Function
	Select CD Player
	Play/Pause
	Skip/Fast Forward
	Skip/Fast Reverse
	Stop
	Eject CD

**How to play CD's with MP3 and other formats?**

The built-in CD player supports CD-DA, CD-R, CD-RW, CD-ROM (both single and multi session) and MP-3 formats. The CD player will play CD's in these formats exactly as it plays a regular audio CD.

**How to play MP3 CD-R/W with several Albums?**

It is possible to organize MP3 files with directories (folders) on a CD-R/W. The Geneva Sound System will play such a hierarchy in a simplified way - all files are played as if they would be in one large directory.



**Can I play 8 cm CD's?**

No.

**FM radio:**

**How to control the FM radio using the remote control?**

You can control the built-in FM radio using the remote control supplied with the Geneva Sound System. Simply follow the instructions in the table below to perform control the various functions:

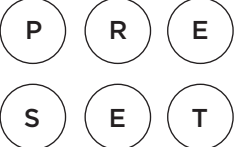
Key	Function
	Select FM radio. Functions even when device is turned off.
	Press once to increase the frequency by 0.5 MHz. Hold to start the auto seek mode.
	Press once to decrease the frequency by 0.5 MHz. Hold to start the auto seek mode.
	Station preset keys. Press to select a station. Hold to store the current station.

#### How to select a FM radio station?

1. Press 'FM' on the remote control.
2. Use the << or >> keys to select a station: one click increases or decreases the frequency.
3. The number on the LED display under the Grille indicates the current frequency in MHz (e.g. "88.7" on display means 88.7 MHz).
4. To scan through frequencies, hold down the << or the >> key for a few seconds and the FM radio searches for the next station automatically. When a station has been found, the automatic search stops. To keep scanning, repeat the action.

#### How to store your favorite FM radio station in a preset?

1. Select your favorite radio station using the << or >> keys on the remote control.
2. You have six presets (a preset memorizes the frequency of the station) available – these are the following six keys on your remote control:

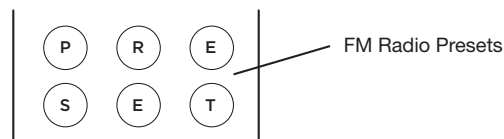

38

3. Select one of the 6 preset keys on the remote control, and hold it down until 'store' appears on the LED display in the Grille of the Geneva Sound System. The station has now been stored and can be retrieved using the selected preset key.

#### How to play a FM radio station that is stored in the presets?

1. Press the FM key on the remote control.
2. Simply press one of the six preset keys once and the stored FM station will be received.

#### How to erase or overwrite a preset?

Stored presets do not need to be erased - just use the steps set out in 3.13 above to overwrite an existing preset and to store a new radio station in a preset.

#### How to connect the FM radio antenna?

The Geneva Sound System is FM ready and it has a built-in FM tuner. To get radio reception you need to connect the External Antenna that is enclosed with the accessory bag.

You find the External Antenna Connector under the Geneva Sound System on the Bottom Panel.

Note: If you use the special Geneva aluminum floor stand with the Geneva Sound System, you can fold the external antenna and place it within the tube. The assembly manual provided with the stand sets out the details on how to do this.

English

39

**Line in:**

**How to connect a Computer, iPod Shuffle or another MP3 player to the Geneva Sound System using the 1/8 inch (3.5 mm) input?**

1. If there is an iPod in the dock of the Geneva Sound System, please remove it.
2. Use the enclosed MP3 Player cable to connect to a Computer, an iPod Shuffle or any other type of MP3 player that can be connected with such cable. Insert MP3 Player cable plug into the 1/8 inch (3.5 mm) auxiliary audio input located on the panel under the lid on top of the cabinet, between the 4 keys.
3. Plug the cable into the headset output connector from the MP3 player.
4. Press the iPod key on the remote control and start playing the contents of the device you have connected.

Note that you cannot control any such device using the Geneva Sound System remote control, but instead using controls available for the connected device.

**How to connect a TV, Computer, VCR, DVD player or a game console to the Geneva Sound System using the "Line In" input?**

Use the enclosed Line in (RCA) cable to connect the Geneva Sound System to any device that has a RCA audio out connector. First connect the Line In cable to the device you want to connect with the Geneva Sound System, and then connect the cable to the Line In connector (RCA Jack input) located on the Bottom Panel under the Cabinet. Press the Line In key on the remote control and start playing the content of the device you have connected. Note that you cannot control any such device using the Geneva Sound System remote control, but instead use the controls available for the connected device.

### 3. Troubleshooting, Service and Support

**Troubleshooting and Support:**

1. If the system does not function as expected, first carefully read this manual to ensure that it is being correctly operated.
2. If the problem persists, you can access our troubleshooting database available on the web at [www.genevalab.com](http://www.genevalab.com) and select support page.
3. If not successful, contact our customer support:

**Service and Repair:**

If the product is damaged and needs repair, please contact Geneva Lab by phone or email to be referred to an authorized service center. For repair under the Limited Warranty Period, see terms on the web at [www.genevalab.com](http://www.genevalab.com) and select support page or consult your dealer.

**Technical Support:**

[productsupport@genevalab.com](mailto:productsupport@genevalab.com)

**Customer Service Telephone Number:**

see Geneva Lab Website [www.genevalab.com](http://www.genevalab.com) and select support page for your local support number.

**Website**

[www.genevalab.com](http://www.genevalab.com)

## 4. Made for iPod & Technology Partners



The "Made for iPod" logo indicates that this product has been designed specifically to work with iPod. The manufacturer certifies that this accessory has been made in accordance with the high standards of quality and performance that you expect from iPod and Apple.

### **Technology Partners:**

Geneva Lab Corporation uses some of the world's leading developers of audio technologies to make the Geneva Sound System a very advanced product.

MPEG Layer-3 Audio Coding Technology licensed from Fraunhofer IIS and Thomson.

## **D2AUDIO**

DIGITAL AMPLIFIERS

D2Audio's unique "Intelligent Digital Amplifiers" have impressed professionals and audiophiles for years. Our patented amplifier technology constantly optimizes the audio signal to deliver the best pure digital performance and the highest sound quality available.

## **EmbracingSound™**

"EmbracingSound™ is the technology for consumers and professionals alike to experience sound. As EmbracingSound™ is utilizing two very closely spaced speakers you will experience what is really in the recording with better resolution and clarity than ever before. Just sit back and experience all your music and you will most probably find new favorites as well as making excursions in to music genres that you were totally unfamiliar with before. Just let the experience guide you!

More details can be found on the [www.genevalab.com](http://www.genevalab.com) website.

## **5. Technical Specifications:**

For detailed technical specifications for this product, please go to our website [www.genevalab.com](http://www.genevalab.com) and select support page, where you can download the detailed technical specifications for any of our products.

© 2007 G-Lab GmbH. All rights reserved

*Under the copyright laws, this manual may not be copied, in whole or in part, without the written consent G-Lab GmbH.*

*Geneva™ is a trademark of G-Lab GmbH.*

*D2Audio and D2A are registered trademarks, while the D2Audio Digital Amplifier logo is a trademark of D2Audio Corporation.*

*iPod is a trademark of Apple Computer, Inc. registered in the U.S. and other countries.*

*The trademark EmbracingSound™ and the Embracing Sound Experience logo are owned by Embracing Sound Experience AB.*

*Geneva Sound System, User Manual, Version v2.0-EU-E*